

Power supplies

Phaseo ABL7, ABL8

Single phase and 3-Phase power supplies
100 V to 500 V - 7 W to 960 W

Catalog

January 2019



Quick access to Product information

Select your Catalog, your Training

Digi-Cat

The complete digital catalog for industrial automation



Makes your choice easy every day, everywhere!



With just 3 clicks, you can reach the 7,000 pages of the Industrial Automation & Control catalog, in both English and French.

- Digi-Cat is available on a USB key (for PC). To get your Digi-Cat, please contact your local center
- Download Digi-Cat from this address:

<http://digi-cat.schneider-electric.com/download.html>

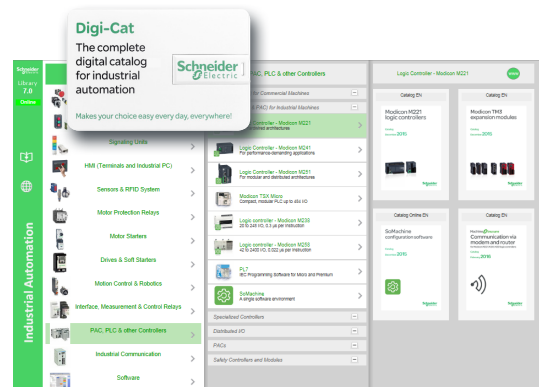

Find your training

- Find the right training for your needs
- Locate the training center with the selector tool, using this address:

<http://www.schneider-electric.com/b2b/en/services/training/technical-training.jsp>

then click on

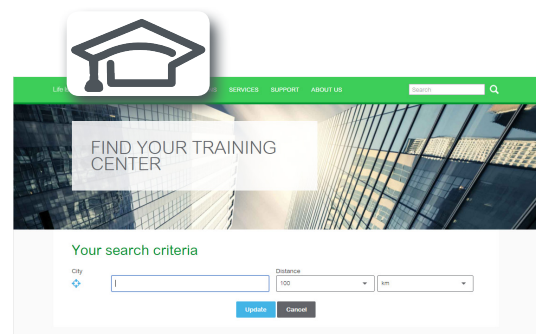
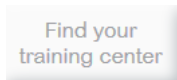

Life Is On



General content

Power supplies

Phaseo ABL7, ABL8

Selection guide: Regulated switch mode power supplies and Function modules page 2

- **Regulated switch mode power supplies** page 4
 - General presentation page 4
 - ABL8MEM/ABL7RM (Modular): 7 to 60 W - Rail mounting
 - Presentation, Description page 6
 - Combination, References page 7
 - ABL8REM/ABL7RP (Optimum): 60 to 120 W - Rail mounting
 - Presentation, Description page 8
 - Combination, References page 9
 - ABL8RP/ABL8WP (Universal): 72 to 960 W - Wide input voltage range - Mounting on rail
 - Presentation page 10
 - Description page 11
 - Combination page 12
 - References page 13
 - **Function modules**
Only compatible with Phaseo ABL8RP/ABL8WPS (Universal) power supplies
 - ABL8DCC:  Converter modules
 - Presentation, Description page 14
 - References page 15
 - ABL8B: Solutions to microbreaks and power outages
 - Presentation page 16
 - Description, Functions page 18
 - References page 19
 - ABL8RED24400: Redundancy solution
 - Presentation, Description page 20
 - References page 21
 - ABL8PRP24100: Solution for discriminating protection of the application
 - Presentation, Description page 22
 - References page 23
 - **Product reference index** page 24

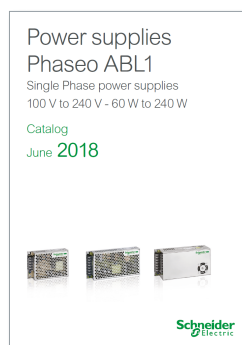

[DIA3ED2170402EN](#)



[DIA3ED2170404EN](#)



[DIA3ED2170403EN](#)

 Other offers, consult the catalogs

Power supplies

Phaseo ABL7, ABL8
Regulated switch mode power supplies and function modules

Applications	Regulated switch mode power supplies		Function modules <i>Only compatible with Phaseo ABL8RP/ABL8WPS (Universal) power supplies</i>				
	ABL8MEM/ABL7RM (Modular): 7 to 60 W - Mounting on rail ABL8REM/ABL7RP (Optimum): 60 to 120 W - Mounting on rail		ABL8RP/ABL8WP (Universal): 72 to 960 W - Wide input voltage range. Mounting on rail		ABL8DCC: converter modules 24 V 24 V 5-12 V	ABL8B: solutions to microbreaks and power outages	ABL8RED24400: redundancy solution



Input voltage	100...240 V ~ 120...250 V 24 V			
Connection to world-wide line supplies	United States - 120 V (in phase-to-neutral) - 240 V (in phase-to-phase)			
	Europe - 230 V (in phase-to-neutral) - 400 V (in phase-to-phase)			
	United States - 277 V (in phase-to-neutral) - 480 V (in phase-to-phase)			
Certifications	CE marking, UL (508), CSA (60950-1), EAC, RCM, TÜV, KC (1)			
Conformity to standards	EN 60950-1, EN 61000-3-2, EN 61000-3-3, EN 61000-6-2, EN 61000-6-3, EN 55022, EN 55024 (2)			
IEC/EN 61000-3-2 conformity	Yes for ABL7RP, not for ABL8REM and not applicable for ABL8MEM and ABL7RM			
Protection against undervoltage	Yes			
Protection against overloads and short-circuits	Yes, voltage detection. Automatic restart on elimination on the fault			
Diagnostic relay	-			
Compatibility	with function modules			
	-			
Power reserve (Boost)	with power supplies			
	-			
Output voltage	1,25 to 1,4 In during 1 minute, depending on model (with ABL8MEM) No			
Output current	5 V 24 V	12 V 24 V	48 V 24 V	
	0.3 A		ABL8MEM24003	
	0.6 A		ABL8MEM24006	
	1.2 A		ABL8MEM24012	
	2 A	ABL8MEM12020		
	2.5 A		ABL7RM24025 ABL7RP4803	
	3 A		ABL8REM24030	
	4 A	ABL8MEM05040		
	5 A	ABL7RP1205	ABL8REM24050	
	6 A			
	10 A			
	20 A			
	40 A			
	Pages	6	6: ABL8MEM/ABL7RM (Modular) 8: ABL8REM/ABL7RP (Optimum)	8

Input voltage	100...120 V ~ and 200...500 V ~ (3)	380...500 V ~	24 V 24 V	24 V 24 V	24 V 24 V
Connection to world-wide line supplies	Single-phase (N-L1) or 2-phase (L1-L2) connection	-	-	-	-
	Single-phase (N-L1) connection	3-phase (L1-L2-L3) connection	-	-	-
	-	3-phase (L1-L2-L3) connection	-	-	-
Certifications	CE marking, UL (508), CSA (60950-1), CB Scheme, EAC, RCM, TÜV, KC (1)	CE marking, UL (508), CSA (60950-1), EAC, RCM (1)	CE marking, UL (508), CSA (60950-1), EAC, RCM (1)	CE marking, UL (508), CSA (60950-1), EAC, RCM (1)	CE marking, UL (508), CSA (60950-1), EAC, RCM (1)
Conformity to standards	EN 60950-1, EN 61000-3-2, EN 61000-3-3, EN 61000-6-2, EN 61000-6-3, EN 55022, EN 55024 (2)	EN 60950-1, EN 61000-3-2, EN 61000-3-3, EN 61000-6-2, EN 61000-6-3, EN 55022, EN 55024 (2)	EN 60950-1, EN 61000-6-2, EN 61000-6-3, EN 55022, EN 55024 (2)	EN 60950-1, EN 61000-6-2, EN 61000-6-3, EN 55022, EN 55024 (2)	EN 60950-1, EN 61000-6-2, EN 61000-6-3, EN 55022, EN 55024 (2)
IEC/EN 61000-3-2 conformity	Yes	-	-	-	-
Protection against undervoltage	Yes	-	-	-	-
Protection against overloads and short-circuits	Yes, current limitation or undervoltage detection	Yes, current limitation	-	-	-
Diagnostic relay	Yes, depending on model	Yes, depending on model	Yes	Yes	-
Compatibility	Yes with buffer module, battery and battery control modules, redundancy module and discriminating downstream protection module	Yes with buffer module, battery and battery control modules, redundancy module and discriminating downstream protection module	-	-	-
	-	ABL8RP/ABL8WP (Universal)	-	-	-
Power reserve (Boost)	1,5 In during 4 secondes	No	-	-	-
Output voltage	24 V 24 V	5 V 7...12 V	24 V 24 V	24 V 24 V	24 V 24 V
Output current					
	Pages	10	14	16	20

(1) Please consult detail on certifications for each reference in the individual data sheet, see on our web site www.schneider-electric.com
 (2) Please consult detail on conformity to standards for each reference in the individual data sheet, see on our web site www.schneider-electric.com
 (3) Except ABL8RPM24200. ~ 100...120 V and ~ 200...240 V.

Phaseo power supplies and transformers

Regulated switch mode power supplies



Phaseo ABL8MEM/ABL7RM (Modular)



Phaseo ABL8REM/ABL7RP (Optimum)



Phaseo ABL8RP/ABL8WP (Universal)

Presentation

The Phaseo electronic switch mode power supply offer is designed to provide the DC voltage necessary for the PLC and automation system equipment control circuits.

■ Phaseo industrial regulated switch mode power supplies are available in 3 ranges: ABL8MEM/ABL7RM (Modular), ABL8REM/ABL7RP (Optimum), and ABL8RP/ABL8WP (Universal).

■ Phaseo switch mode power supplies are fully electronic and their output voltage is regulated. The use of electronics makes it possible to significantly improve the performance of these power supplies, which offer:

- Compact dimensions
- Integrated overload, short-circuit, overvoltage, and undervoltage protection (1)
- Wide input voltage range for the ABL8RP/ABL8WP (Universal) range
- High degree of output voltage stability
- Efficiency

- Diagnostics via LEDs on the front panel or remote diagnostics via relay contact for the ABL8RP/ABL8WP (Universal) range

■ Phaseo power supplies deliver a stabilized $\overline{\text{---}}$ output voltage that is precise to 3%, whatever the load from a \sim line supply, within the following ranges:

- 100 to 240 V \sim for phase-to-neutral (N-L1) or phase-to-phase (L1- L2) connections for the ABL8MEM/ABL7RM (Modular) and ABL8REM/ABL7RP (Optimum) ranges
- 85 to 550 V \sim for phase-to-neutral (N-L1) or phase-to-phase (L1- L2) connections for the ABL8RP/ABL8WP (Universal) range
- 360 to 550 V \sim for 3-phase connections (L1-L2-L3) for the ABL8RP/ABL8WP (Universal) range

■ They comply with IEC standards and are UL, CSA, TÜV, and C-Tick certified for industrial use. The inclusion of overload and short-circuit protection makes downstream protection unnecessary if discrimination is not required. To achieve discrimination, it is advisable to use discriminating electronic downstream protection modules.

■ Phaseo power supplies incorporate:

- An output voltage adjustment potentiometer to help compensate for any line voltage drops in installations with long cable runs
- Direct mounting on 35 mm (1.37 in.), \perp rails (optional for the ABL1REM/1RPM range) and 75 mm (2.95 in.) \perp rails (for the ABL8REM/ABL7RP (Optimum) range)

Phaseo ABL8MEM/ABL7RM (Modular)

■ The ABL8MEM/ABL7RM (Modular) range meets all the needs of simple automation systems with power ratings from 7 to 60 W and an output voltage of 5 V $\overline{\text{---}}$, 12 V $\overline{\text{---}}$, or 24 V $\overline{\text{---}}$.

- The shape and compact nature of its casing mean that it can be mounted directly on a panel in a modular distribution panel (by means of retractable fixing lugs) or on a \perp rail in a cabinet.
- Wires can exit at the top or bottom of the unit as required (except on the ABL7RM24025 model).

Phaseo ABL8REM/ABL7RP (Optimum)

■ The ABL8REM/ABL7RP (Optimum) range is the low-cost solution for applications supplied with 12 V $\overline{\text{---}}$, 24 V $\overline{\text{---}}$, or 48 V $\overline{\text{---}}$ and requiring currents between 2.5 and 5 A.

□ The ABL8REM/ABL7RP (Optimum) range of Phaseo power supplies delivers a voltage that can give the PLC logic states. In the event of an overload the power supply protection trips; when the overload has disappeared, the power supply reverts to its nominal state.

□ Since the ABL8REM/ABL7RP (Optimum) power supplies do not have PFC (power factor correction), they do not meet the requirements of standard IEC/EN 61000-3-2 (except models ABL7RP1205 and ABL7RP4803).

Phaseo ABL8RP/ABL8WP (Universal)

■ The ABL8RP/ABL8WP (Universal) range covers power ratings from 72 to 960W in 24 V $\overline{\text{---}}$ and adapts to the majority of power distribution networks used throughout the world. The same power supply can thus be connected phase-to-neutral (N-L1) or phase-to-phase for line supplies ranging from 100 V \sim to 500 V \sim nominal. This ranges offers:

- Diagnostic functions (local or remote)
- User choice of operating mode in the event of an overload (current limiting or stop)
- Function modules to ensure continuity of service:
 - Buffer module and Battery check modules for protection against microbreaks or prolonged outages
 - Redundancy module for paralleling and redundancy functions
 - Protection modules for discriminating protection against application overloads
- A power reserve (boost function) for absorbing the transient current peaks required by the application

■ With the ABL8RP/ABL8WP (Universal) power supplies, it is possible to meet the need for auxiliary voltage (5 V $\overline{\text{---}}$ to 15 V $\overline{\text{---}}$) using $\overline{\text{---}}$ / $\overline{\text{---}}$ converter modules.

■ The incorporation of a PFC (power factor correction) input filter reduces harmonic pollution to a minimum level across the entire ABL8RP/ABL8WP (Universal) range, ensuring compliance with the requirements of standard IEC/EN 61000-3-2.

(1) The inclusion of overload and short-circuit protection makes downstream protection unnecessary if discrimination is not required (see page 22).

Phaseo power supplies and transformers

Regulated switch mode power supplies

Characteristics of the 24 V $\overline{\text{---}}$ operating voltage

The permissible tolerances for the operating voltage are listed in publications IEC/EN 61131-2 and DIN 19240.

For a nominal voltage U_n of 24 V $\overline{\text{---}}$, the extreme operating values range from -15% to +20% of the voltage U_n , whatever the supply fluctuations in the range -10% to +6% (defined by standard IEC 38) with load variations of 0 to 100% of nominal current I_n .

The 24 V $\overline{\text{---}}$ Phaseo power supplies are designed to provide an output voltage within these ranges.

It may be necessary to use a voltage measurement relay to detect when the normal voltage limits are being surpassed and to deal with the consequences of this. The ABL8RP/ABL8WP (Universal) range has integrated voltage detection.

Recommendations for use of the 24 V $\overline{\text{---}}$ voltage

The Phaseo power supplies can be used to supply protection extra low voltage (PELV) or safety extra low voltage (SELV) control circuits in compliance with standard IEC/EN 60364-4-41.

They have the following characteristics:

- Double insulation between the input circuit (connected to the line supply) and the low voltage output circuit via an integrated isolation transformer
- Internal device limiting the output voltage to less than 60 V

Harmonic pollution (power factor)

The current drawn by a power supply is not sinusoidal. This leads to the generation of harmonic currents that pollute the distribution network.

European standard IEC/EN 61000-3-2 limits the harmonic currents produced by power supplies.

This standard covers all devices between 75 and 1000 W, drawing up to 16 A per phase, and connected directly to the public distribution network. Devices connected downstream of a private, low voltage, general transformer are therefore excluded. Regulated switch mode supplies always consume harmonic currents; it is therefore recommended that a filter circuit (power factor correction or PFC) is added to comply with standard IEC/EN 61000-3-2.

Phaseo ABL8RP/8WP (Universal), ABL1RPM12083, ABL1RPM24042, and ABL1REM24042 power supplies conform to IEC/EN 61000-3-2 and can therefore be connected directly to public distribution networks.

Since Phaseo ABL8MEM240●●, ABL7RM24025, ABL1REM12050, and ABL1REM24025 power supplies have power ratings that are less than 75 W, they are not subject to the requirements of standard IEC/EN 61000-3-2.

They can therefore be connected directly to public distribution networks.

Phaseo ABL8REM, ABL1REM24062, ABL1RPM24062, ABL1REM24100, and ABL1RPM24100 power supplies must only be connected downstream of a private, low voltage, general transformer.

Power supplies

Phaseo ABL7, ABL8

ABL8MEM/ABL7RM (Modular) 7 to 60 W -

Rail mounting

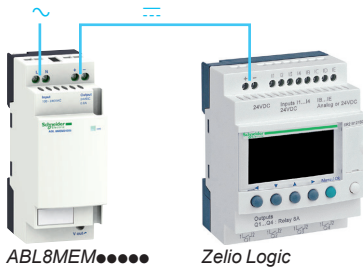

ABL8MEM/ABL7RM (Modular) regulated switch mode power supplies

The ABL8MEM/ABL7RM (Modular) power supply offer is designed to provide the DC voltage necessary for the control circuits of automation system equipment consuming 7 to 60 W in 5, 12, and 24 V DC .

Comprising six products, this range meets the needs encountered in industrial, commercial, and residential applications. These electronic switch mode power supplies provide a quality of output current that is suitable for the loads supplied and compatible with the **Zelio Logic** and **Modicon M221** ranges, and small **Modicon M340**, **Premium**, and **Quantum** configurations.

Clear guidelines are given on selecting the upstream protection devices that are often used with them to provide a comprehensive, usable solution.

ABL8MEM/ABL7RM (Modular) supplies can be connected in phase-to-neutral (N-L1) or phase-to-phase (1) (L1-L2). They deliver a voltage that is precise to within 3%, whatever the load and whatever the type of line supply, within a range of 85 to 264 V \sim . Conforming to IEC standards and UL and CSA certified, they are suitable for universal use. The inclusion of overload and short-circuit protection makes downstream protection unnecessary if discrimination is not required.

Due to their low power, ABL8MEM/ABL7RM (Modular) power supplies consume very little harmonic current and thus are not subject to the requirements of standard IEC/EN 61000-3-2 concerning harmonic pollution.

ABL8MEM/ABL7RM (Modular) power supplies have protection devices to ensure optimum performance of the automation system with an automatic reset mode.

The products are equipped with an output voltage adjustment potentiometer to compensate for any line voltage drops in installations with long cable runs.

These power supplies also have a cable run inside the case so that the outputs can be connected at the top or bottom of the product as required.

These power supplies are designed for direct mounting on 35 mm U rails, or on a mounting plate using their retractable mounting lugs.

There are six references in the Phaseo ABL8MEM/ABL7RM (Modular) product range:

ABL8MEM24003	7 W	0.3 A	24 V DC
ABL8MEM24006	15 W	0.6 A	24 V DC
ABL8MEM24012	30 W	1.2 A	24 V DC
ABL7RM24025	60 W	2.5 A	24 V DC
ABL8MEM05040 power supply	20 W	4 A	5 V DC
ABL8MEM12020	25 W	2 A	12 V DC

(1) 240 V \sim nominal

Description

ABL8MEM



ABL7RM24025

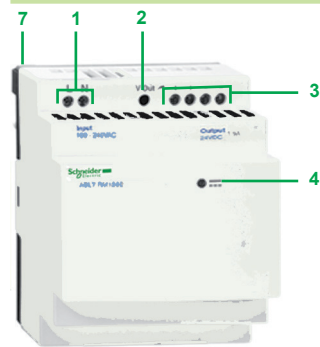

- 1 2.5 mm² screw terminal for connection of the incoming AC voltage
- 2 Output voltage adjustment potentiometer
- 3 2.5 mm² screw terminal for connection of the output voltage
- 4 LED indicating presence of DC output voltage
- 5 Duct for throughwiring of the output voltage conductors at the bottom (except for model ABL7RM24025)
- 6 Clip-on marker tag (except for model ABL7RM24025)
- 7 Retractable mounting lugs for panel mounting

Power supplies

Phaseo ABL7, ABL8

ABL8MEM/ABL7RM (Modular) 7 to 60 W -
Rail mounting

Selection of protection on the power supply primary

Line supply type	100 to 240 V ~ single-phase		
Type of protection	Thermal-magnetic circuit breaker	Miniature circuit breaker	gG fuse
	GB2 (IEC/CSA-c/US)	Multi9 C60 (IEC, UL/CSA)	
ABL8MEM05040	GB2CB07 (1) GB2CD07 (1) GB2DB07 (1) GB2CS07 (1)	M9F23202	2 A
ABL8MEM12020			
ABL8MEM24003			
ABL8MEM24006			
ABL8MEM24012			
ABL7RM24025	GB2CB08 (1) GB2CD08 (1) GB2DB08 (1) GB2CS08 (1)	M9F23203	3 A

(1):

CB: for single-pole circuit breaker with magnetic trip threshold 12 to 16 In

CD: for single-pole + neutral circuit breaker with magnetic trip threshold 12 to 16 In

DB: for 2-pole circuit breaker with magnetic trip threshold 12 to 16 In

CS: for single-pole circuit breaker with magnetic trip threshold 5 to 7 In

Power supply service life (MTBF)

	Test conditions	MTBF (h)	Calculation method
ABL8MEM05040	–	191,491	MIL-HDBK-217F
ABL8MEM24003	–	561,085	MIL-HDBK-217F
ABL8MEM24006	–	561,085	MIL-HDBK-217F
ABL8MEM24012	–	406,032	MIL-HDBK-217F
ABL8MEM12020	–	Currently being defined	MIL-HDBK-217F
ABL7RM24025	–	Currently being defined	MIL-HDBK-217F

References for ABL8MEM/ABL7RM (Modular) regulated switch mode power supplies

	Input voltage	Secondary		Reset	Conformity to standard IEC/EN 61000-3-2 (1)	Reference	Weight kg/lb	
		Output voltage	Nominal power					Nominal current
 ABL8MEM05040/12020/24012	100...240 V -15%, +10% 50/60 Hz	Single-phase (N-L1) or 2-phase (L1-L2) connection						
		5 V $\overline{\text{---}}$	20 W	4 A	Automatic	Not applicable	ABL8MEM05040	0.195/ 0.430
		12 V $\overline{\text{---}}$	25 W	2 A	Automatic	Not applicable	ABL8MEM12020	0.195/ 0.430
		24 V $\overline{\text{---}}$	7 W	0.3 A	Automatic	Not applicable	ABL8MEM24003	0.100/ 0.220
			15 W	0.6 A	Automatic	Not applicable	ABL8MEM24006	0.100/ 0.220
			30 W	1.2 A	Automatic	Not applicable	ABL8MEM24012	0.195/ 0.430
			60 W	2.5 A	Automatic	Not applicable	ABL7RM24025	0.255/ 0.562

ABL8MEM24003/24006



ABL7RM24025

Description	Use	Order in multiples of	Unit reference	Weight kg/lb
Clip-on marker tags	Replacement parts for ABL8MEM power supplies	100	LAD90	0.030/ 0.066

(1) Due to their power < 75 W, ABL8MEM/ABL7RM (Modular) power supplies are not subject to the requirements of standard IEC/EN 61000-3-2.

Power supplies

Phaseo ABL7, ABL8

Regulated switch mode power supplies ABL8REM/
ABL7RP (Optimum) 60 to 144 W - Rail mounting

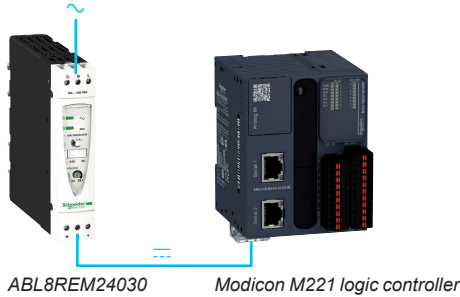

Switch mode power supplies: range ABL8REM/ABL7RP (Optimum)

The ABL8REM/ABL7RP (Optimum) power supply offer is designed to provide the DC voltage necessary for the control circuits of automation system equipment consuming 60 to 144 W in 12, 24 and 48 V DC . Comprising four products, this range meets the needs encountered in industrial, commercial, and residential applications. With phase-to-neutral (N-L1) or phase-to-phase (1) (L1-L2) connection, these slim electronic switch mode power supplies provide a quality of output current that is suitable for the loads supplied and compatible with both Modicon logic controllers and small Modicon M340, Premium and Quantum configurations, making them ideal partners.

Their simplified characteristics in comparison with the ABL8RP/8WP offer also make them the low-cost solution for applications less affected by constraints with the line supply, such as harmonic pollution and outages. Clear guidelines are given on selecting the upstream protection devices which are often used with them, and thus a comprehensive solution is provided that can be used in total safety.

The ABL8REM/ABL7RP (Optimum) power supplies delivers a voltage that is precise to 3%, whatever the load and whatever the type of line supply, within a range of 85 to 264 V \sim . Conforming to IEC standards and UL, CSA and TUV certified, they are suitable for universal use. The inclusion of overload and short-circuit protection makes downstream protection unnecessary if discrimination is not required.

- ABL8REM power supplies do not have an anti-harmonic filter and do not satisfy the requirements of standard IEC/EN 61000-3-2 concerning harmonic pollution.
- ABL7RP power supplies, however, are equipped with a PFC (Power Factor Correction) filter, thus ensuring compliance with standard IEC/EN 61000-3-2.

ABL8REM/ABL7RP (Optimum) power supplies have protection devices to give optimum performance of the automation system with an automatic reset mode. In the event of an overload or short-circuit, the integrated protection interrupts the current supply before the output voltage drops below 19 V DC . The protection device resets itself automatically (no action or change a fuse).

Each product is equipped with an output voltage adjustment potentiometer to compensate for any line voltage drops in installations with long cable runs. The power supplies are designed for direct mounting on 35 and 75 mm rails.

There are four references available in the ABL8REM/ABL7RP (Optimum) Phaseo range:

■ ABL8REM24030	72 W	3 A	24 V DC
■ ABL8REM24050	120 W	5 A	24 V DC
■ ABL7RP1205	60 W	5 A	12 V DC
■ ABL7RP4803	144 W	3 A	48 V DC

Description

- 1 2.5 mm² enclosed screw terminals for connection of the input voltage (single-phase N-L1, phase-to-phase L1-L2 (1))
- 2 Protective glass flap
- 3 Input voltage status LED (orange)
- 4 Output DC voltage status LED (green)
- 5 Locking catch for the glass flap (sealable)
- 6 Clip-on marker tag
- 7 Output voltage adjustment potentiometer
- 8 2.5 mm² enclosed screw terminal block for connection of the DC output voltage (1) 240 V \sim nominal

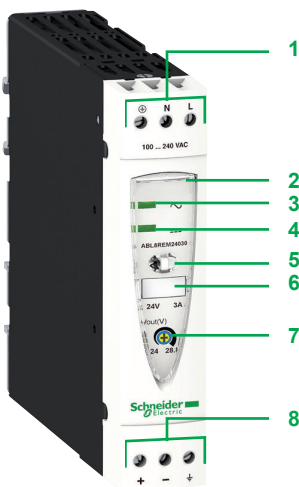

Power supplies

Phaseo ABL7, ABL8

Regulated switch mode power supplies ABL8REM/
ABL7RP (Optimum) 60 to 144 W - Rail mounting

Selection of protection on the power supply primaries						
Type of line supply	100 V ~			240 V ~		
Type of protection	Thermal-magnetic circuit breaker		gG fuse	Thermal-magnetic circuit breaker		gG fuse
	GB2 (CEI/CSA-c/US)	Multi9 C60 (CEI, UL/CSA)		GB2 (CEI/CSA-c/US)	Multi9 C60 (CEI, UL/CSA)	
ABL8REM24030	GB2CB07 (1) GB2CD07 (1) GB2DB07 (1) GB2CS07 (1)	–	2 A	GB2CB06 (1) GB2CD06 (1) GB2DB06 (1) GB2CS06 (1)	M9F23201	2 A (2)
ABL8REM24050	GB2CB08 (1) GB2CD08 (1) GB2DB08 (1) GB2CS08 (1)	M9F23203	4 A	GB2CB07 (1) GB2CD07 (1) GB2DB07 (1) GB2CS07 (1)	M9F23202	2 A
ABL7RP1205	GB2CB06 (1) GB2CD06 (1) GB2DB06 (1) GB2CS06 (1)	M9F23201	2 A	GB2CB06 (1) GB2CD06 (1) GB2DB06 (1) GB2CS06 (1)	M9F23201	2 A (2)
ABL7RP4803	GB2CB08 (1) GB2CD08 (1) GB2DB08 (1) GB2CS08 (1)	M9F23203	4 A	GB2CB07 (1) GB2CD07 (1) GB2DB07 (1) GB2CS07 (1)	M9F23202	2 A

(1) Complete the reference by replacing ●● with:

CB: for single-pole circuit-breaker with magnetic trip threshold 12 to 16 In

CD: for single-pole + neutral circuit-breaker with magnetic trip threshold 12 to 16 In



DB: for 2-pole circuit-breaker with magnetic trip threshold 12 to 16 In

CS: for single-pole circuit-breaker with magnetic trip threshold 5 to 7 In

(2) 1 A version not available.

Service life (MTBF)			
	Test conditions	MTBF (h)	Calculation method
ABL8REM24030	110 V ~	115,104	MIL-HDBK-217F
	220 V ~	116,354	MIL-HDBK-217F
ABL8REM24050	110 V ~	104,640	MIL-HDBK-217F
	220 V ~	105,777	MIL-HDBK-217F
ABL7RP1205	–	Currently being defined	MIL-HDBK-217F
ABL7RP4803	–	Currently being defined	MIL-HDBK-217F

ABL8REM/ABL7RP (Optimum) range of Phaseo regulated switch mode power supplies

	Input voltage	Secondary			Reset	Conformity to standard IEC/EN 61000-3-2	Reference	Weight kg/lb
		Output voltage	Nominal power	Nominal current				
Single-phase (N-L1) or phase-to-phase (L1-L2) connection								
 ABL8REM24030	100...240 V ~ - 15%, + 10% 50/60 Hz and 120...220 V ~ (1)	24 V ~	72 W	3 A	Automatic	No	ABL8REM24030	0.520/ 1.146
		120 V ~	120 W	5 A	Automatic	No	ABL8REM24050	1.000/ 2.205
 ABL8REM24050	100...240 V ~ - 15%, + 10% 50/60 Hz	12 V ~	60 W	5 A	Automatic or manual	Yes	ABL7RP1205	1.000/ 2.205
		48 V ~	144 W	2.5 A	Automatic or manual	Yes	ABL7RP4803	1.000/ 2.205
 ABL7RP1205, ABL7RP4803								

(1) CULus 508, CCSAus and TUV 60950-1 certifications are not valid for DC input voltage.

Power supplies

Phaseo ABL7, ABL8

ABL8RP/ABL8WP (Universal) 72 to 960 W - Wide input voltage range - Rail mounting

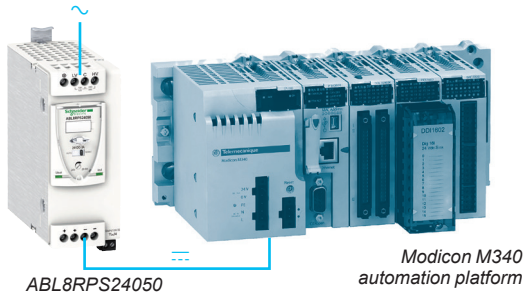

ABL8RP/ABL8WP (Universal) regulated switch mode power supplies

The ABL8RP/ABL8WP (Universal) power supply offer is designed to provide the DC voltage necessary for the control circuits of automation system equipment. Comprising six products, this range meets the needs encountered in industrial and commercial applications. These compact electronic switch mode power supplies provide a quality of output current that is suitable for the loads supplied and compatible with the **Modicon M340**, **Modicon M580**, **Modicon Premium**, and **Modicon Quantum** ranges. When used with additional function modules, they ensure continuity of service in the event of power outages. Clear guidelines are given on selecting the function modules and upstream protection devices that are often used with them to provide a comprehensive, usable solution.

ABL8RP/ABL8WP (Universal) power supplies must be connected in phase-to-neutral or phase-to-phase for ABL8RPS/8RPM, and in 3-phase for ABL8WPS. They deliver a voltage that is precise to within 3%, whatever the load and whatever the type of line supply, within the following ranges:

- 85 to 132 V ~ and 170 to 550 V ~ for ABL8RPS
- 85 to 132 V ~ and 170 to 264 V ~ for ABL8RPM
- 340 to 550 V ~ for ABL8WPS

Their very wide input voltage range allows a considerable reduction of parts held in stock and offers a distinct advantage in terms of machine design.

Conforming to IEC standards and UL and CSA certified, they are suitable for universal use.

ABL8RPS/RPM and ABL8WPS power supplies are all equipped with a harmonic filter, giving compliance with standard IEC/EN 61000-3-2 concerning harmonic pollution.

ABL8RP/ABL8WP (Universal) power supplies have protection devices to ensure optimum performance of the automation system. Their operating mode can be configured as required by the user:

- Manual reset protection mode: Priority is given to the voltage so as to ensure the PLC logic states and nominal operation of the supplied actuators.
- Automatic reset protection mode: Priority is given to the current to ensure continuity of service until the maintenance team arrives.

Phaseo ABL8RP/ABL8WP (Universal) power supplies also have a power reserve, allowing them to deliver a current of 1.5 I_n at regular intervals. This avoids the need to oversize the power supply if the device has a high inrush current to be able to maintain optimum performance of the automation system.

The diagnostics for the Phaseo ABL8RP/ABL8WP (Universal) range of power supplies are available on the front of the device via LEDs (U_{out} and I_{out}) via a volt-free relay contact (PLC state).

The products are equipped with an output voltage adjustment potentiometer in order to be able to compensate for any line voltage drops in installations with long cable runs.

These power supplies are designed for direct mounting on a 35 mm U rail.

Power supplies

Phaseo ABL7, ABL8

ABL8RP/ABL8WP (Universal) 72 to 960 W - Wide input voltage range - Rail mounting

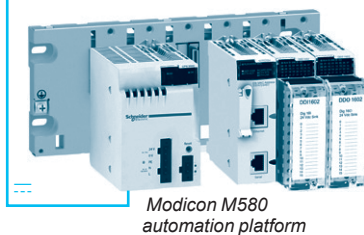

ABL8RP/ABL8WP (Universal) switch mode power supplies (continued)

There are four references available in the Phaseo ABL8RP range with phase-to-neutral or phase-to-phase connection:

■ ABL8RPS24030	72 W	3 A	24 V $\overline{\text{---}}$
■ ABL8RPS24050	120 W	5 A	24 V $\overline{\text{---}}$
■ ABL8RPS24100	240 W	10 A	24 V $\overline{\text{---}}$
■ ABL8RPM24200	480 W	20 A	24 V $\overline{\text{---}}$

There are two references available in the Phaseo ABL8WPS range with 3-phase connection:

■ ABL8WPS24200	480 W	20 A	24 V $\overline{\text{---}}$
■ ABL8WPS24400	960 W	40 A	24 V $\overline{\text{---}}$

A range of function modules also allows functions to be added to the Phaseo ABL8RP/ABL8WP (Universal) power supplies to ensure continuity of service:

- A Buffer module or Battery check modules and their batteries to ensure continuity of service in the event of a power outage
- A Redundancy module to meet the requirements for continuity of service even if the power supply is cut off
- Downstream electronic Protection modules to make the protection in the application discriminating
- Converter modules delivering nominal voltages of 5 and 12 V $\overline{\text{---}}$ from the 24 V $\overline{\text{---}}$ output of the Phaseo ABL8RP/ABL8WP (Universal) power supplies

Description

ABL8RP/ABL8WP (Universal) power supplies

Phaseo **ABL8RPS24●●0/RPM24200/WPS24●00** regulated switch mode power supplies comprise:

- 1 Spring clip for 35 mm $\overline{\text{---}}$ rail
- 2 4 mm² enclosed screw terminals for connection of the AC voltage (single-phase, phase-to-phase, or 3-phase connection)
- 3 Protective glass flap
- 4 Clip-on marker tag
- 5 Locking catch for the glass flap (sealable)
- 6 Protection mode selector
- 7 Output voltage adjustment potentiometer
- 8 Output voltage status LED (green and red)
- 9 Output current status LED (green, red, and orange)
- 10 Screw terminals for connection of the diagnostic relay contact, except **ABL8RPS24030**
- 11 4 mm² (10 mm² on **ABL8WPS24●00** and **ABL8RPM24200**) enclosed screw terminals for connection of the DC output voltage

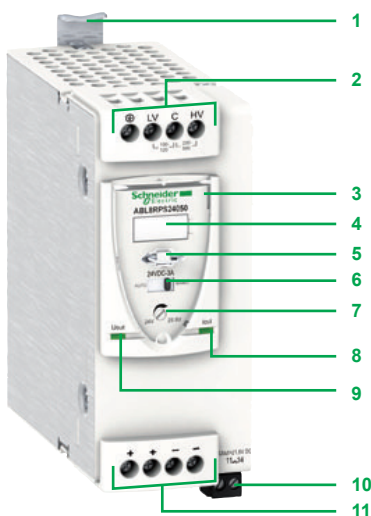

Power supplies

Phaseo ABL7, ABL8

ABL8RP/ABL8WP (Universal) 72 to 960 W - Wide input voltage range - Rail mounting

Selection of protection on the power supply primary

Line supply type	115 V ~ phase-to-neutral			230 V ~ phase-to-phase			400 V ~ phase-to-phase		
	Type of protection	Thermal-magnetic circuit breaker	Miniature circuit breaker	gG/gL fuse	Thermal-magnetic circuit breaker	Miniature circuit breaker	gG/gL fuse	Thermal-magnetic circuit breaker	gG/gL fuse
		GB2 (IEC/CSA-c/US)	Multi9 C60 (IEC, UL/CSA)		GB2 (IEC/CSA-c/US)	Multi9 C60 (IEC, UL/CSA)		GV2 (IEC/UL)	
ABL8RPS24030	GB2CD07	M9F22202	2 A (8 x 32)	GB2CD07	M9F22202	2 A (8 x 32)	GB2RT06 GV2ME06 (1)	2 A (14 x 51)	
ABL8RPS24050	GB2CD08	M9F22203	4 A (8 x 32)	GB2CD07	M9F22202	2 A (8 x 32)	GB2RT06 GV2ME06 (1)	2 A (14 x 51)	
ABL8RPS24100	GB2CD12	M9F22206	6 A (8 x 32)	GB2CD08	M9F22203	4 A (8 x 32)	GB2RT07 GV2ME07 (1)	4 A (14 x 51)	
ABL8RPM24200	GB2CD16	M9F22210	10 A (8 x 32)	GB2CD12	M9F22206	6 A (8 x 32)	-	-	
ABL8WPS24200	-	-	-	-	-	-	GV2ME06 (2)	2 A (14 x 51)	
ABL8WPS24400	-	-	-	-	-	-	GV2ME07 (2)	4 A (14 x 51)	

(1) Single-phase (N-L) or 2-phase (L1-L2) connection
 (2) 3-phase connection (L1-L2-L3)

Service life (MTBF)

	Test conditions	MTBF (h)	Calculation method
Phaseo ABL8RP/ABL8WP (Universal) regulated switch mode power supplies			
ABL8RPS24030	110 V ~	924,000	UTE C80-810
	200...500 V ~	900,000	UTE C80-810
ABL8RPS24050	100 V ~	915,000	UTE C80-810
	200...500 V ~	950,000	UTE C80-810
ABL8RPS24100	110 V ~	613,500	UTE C80-810
	200...500 V ~	892,000	UTE C80-810
ABL8RPM24200	110 V ~	717,000	UTE C80-810
	240 V ~	695,000	UTE C80-810
ABL8WPS24200	320 V ~	691,000	UTE C80-810
	550 V ~	670,000	UTE C80-810
ABL8WPS24400	320 V ~	560,000	UTE C80-810
	550 V ~	593,000	UTE C80-810
Function modules for continuity of service			
ABL8BUF24400	24 V ⋯	1,119,603	UTE C80-810
ABL8BBU24200	24 V ⋯	718,708	UTE C80-810
ABL8BBU24400	24 V ⋯	707,945	UTE C80-810
ABL8RED24400	24 V ⋯	2,488,391	UTE C80-810
ABL8PRP24100	-	Currently being defined	UTE C80-810
ABL8BPK24A03	-	Currently being defined	UTE C80-810
ABL8BPK24A07	-	Currently being defined	UTE C80-810
ABL8BPK24A12	-	Currently being defined	UTE C80-810
⋯ / ⋯ converters			
ABL8DCC05060	24 VDC	1,511,725	UTE C80-810
ABL8DCC12020	24 VDC	1,583,182	UTE C80-810

Power supplies

Phaseo ABL7, ABL8

ABL8RP/ABL8WP (Universal) 72 to 960 W - Wide input voltage range - Rail mounting



ABL8RPS24050



ABL8RPM24200



ABL8WPS24200



ABL8BUF24400



ABL8BBU24200



ABL8RED24400

References for ABL8RP/ABL8WP (Universal) regulated switch mode power supplies

Input voltage	Secondary Output voltage	Nominal power	Nominal current	Reset	Conforming to standard IEC/EN 61000-3-2	Reference	Weight kg/lb
Single-phase (N-L1) or 2-phase (L1-L2) connection							
100...120 V - 200...500 V ~ -15%,+10% 50/60 Hz	24...28.8 V	72 W	3 A	Auto/man	Yes	ABL8RPS24030	0.300/ 0.661
	---	120 W	5 A	Auto/man	Yes	ABL8RPS24050	0.700/ 1.543
	---	240 W	10 A	Auto/man	Yes	ABL8RPS24100	1.000/ 2.205
100...120 V/ 200...240 V ~ -15%,+10% 50/60 Hz	24...28.8 V	480 W	20 A	Auto/man	Yes	ABL8RPM24200	1.600/ 3.527
	---	960 W	40 A	Auto/man	Yes	ABL8WPS24400	2.700/ 5.952
3-phase connection (L1-L2-L3)							
380...500 V ~ ± 10% 50/60 Hz	24...28.8 V	480 W	20 A	Auto/man	Yes	ABL8WPS24200	1.600/ 3.527
	---	960 W	40 A	Auto/man	Yes	ABL8WPS24400	2.700/ 5.952

Function modules for continuity of service (1)

Function	Use	Description	Reference	Weight kg/lb
Continuity after a power outage	Holding time 100 ms at 40 A and 2 s at 1 A	Buffer module	ABL8BUF24400	1.200/ 2.646
	Holding time 9 min at 40 A to 2 hrs at 1 A (depending on use with a battery check module-battery unit and load) (2)	Battery check module, output current 20 A	ABL8BBU24200	0.500/ 1.102
		Battery check module, output current 40 A	ABL8BBU24400	0.700/ 1.543
		3.2 Ah battery module (3)	ABL8BPK24A03	3.500/ 7.716
	7 Ah battery module (3)	ABL8BPK24A07	6.500/ 14.330	
12 Ah battery module (3)	ABL8BPK24A12	12.000/ 26.455		
Continuity after a malfunction	Paralleling and redundancy of the power supply to give uninterrupted operation of the application excluding line supply failures and application overloads	Redundancy module	ABL8RED24400	0.700/ 1.543
Discriminating downstream protection	Electronic protection (1...10 A overload or short-circuit) of 4 output terminals from a Phaseo ABL8RP/ABL8WP (Universal) power supply	Protection module with 2-pole breaking (4) (5)	ABL8PRP24100	0.270/ 0.595

--- / --- converters (1)

Primary (6)	Secondary Output voltage	Nominal current	Reference	Weight kg/lb
Input voltage	ABL8RP/ABL8WP (Universal) power supply module output current			
24 V --- -9%,+24%	2.2 A	5...6.5 V --- 6 A	ABL8DCC05060	0.300/ 0.661
	1.7 A	7...15 V --- 2 A	ABL8DCC12020	0.300/ 0.661

Separate and replacement parts

Description	Use	Composition	Unit reference	Weight kg/lb
Fuse assemblies	For ABL8PRP24100 discriminating Protection module	4 x 5 A, 4 x 7.5 A, and 4 x 10 A	ABL8FUS01	—
	For ABL8BPK24A●● battery	4 x 20 A and 6 x 30 A	ABL8FUS02	—
Clip-on marker labels	All products except ABL8PRP24100	Order in multiples of 100	LAD90	0.030/ 0.066
	For ABL8PRP24100 discriminating Protection module	Order in multiples of 22	ASI20 MACCS5	—
Rail mounting kit	ABL8BPK2403 battery module	—	ABL1A02	—
EEPROM memory	Backup and duplication of ABL8 BBU24●00 battery check module parameters	—	SR2MEM02	0.010/ 0.022

(1) For use with Phaseo ABL8RP/ABL8WP (Universal) power supply

(2) Compatibility table for battery check module-battery unit with holding time depending on the load

(3) Supplied with 20 or 30 A fuse depending on the model

(4) Supplied with four 15 A fuses

(5) Local reset via pushbutton or automatic reset

(6) Voltage from a 24 V --- Phaseo ABL8RP/ABL8WP (Universal) power supply

Power supplies

Phaseo ABL7, ABL8

ABL8DCC Function modules: $\overline{\text{---}}$ / $\overline{\text{---}}$ Converter modules

Supplying 5 V $\overline{\text{---}}$ and 12 V $\overline{\text{---}}$ auxiliary voltages

The Phaseo range offers modules that convert the 24 V $\overline{\text{---}}$ voltage to a 5 to 15 V $\overline{\text{---}}$ voltage.

These modules can be used to make savings in the:

- Upstream protection normally used with the 5 to 15 V $\overline{\text{---}}$ power supply
- Connection to the line supply

There are two references available for this solution:

- **ABL8DCC05060** : 5...6.5 V $\overline{\text{---}}$, 6 A converter module
- **ABL8DCC12020** : 7...15 V $\overline{\text{---}}$, 2 A converter module

Description

5 V $\overline{\text{---}}$ and 12 V $\overline{\text{---}}$ Converter modules

The **ABL8DCC●●0●0** $\overline{\text{---}}$ / $\overline{\text{---}}$ Converter modules comprise:

- 1 Spring clip for 35 mm $\overline{\text{---}}$ rail
- 2 Protective glass flap
- 3 Clip-on marker label
- 4 Locking catch for the glass flap (sealable)
- 5 Output voltage adjustment potentiometer
- 6 Output current status LED (green)
- 7 4 mm² enclosed screw terminals for connection of the 24 V $\overline{\text{---}}$ input voltage
- 8 4 mm² enclosed screw terminals for connection of the 5 V $\overline{\text{---}}$ or 12 V $\overline{\text{---}}$ output voltage



Power supplies

Phaseo ABL7, ABL8

ABL8DCC Function modules: ---/--- Converter modules



ABL8DCC050060/12020

References

--- / --- converters (compatible only with ABL8RP/ABL8WP (Universal) Phaseo power supplies)

Primary (1)	Secondary		Reference	Weight kg/lb
	Output voltage	Nominal current		
24 V c -9%, +24%	2.2 A	5...6.5 V --- 6 A	ABL8DCC05060	0.300/ 0.661
	1.7 A	7...15 V --- 2 A	ABL8DCC12020	0.300/ 0.661

Replacement part

Designation	Composition	Unit reference	Weight kg/lb
Clip-on marker labels	Order in multiples of 100	LAD90	0.030/ 0.066

(1) Voltage from a 24 V --- Phaseo ABL8RP/ABL8WP (Universal) range power supply

Power supplies

Phaseo ABL7, ABL8

ABL8B Function modules: Solutions to microbreaks and power outages

Presentation

The **ABL8B** Function module offer complements the **ABL8RP/ABL8WP (Universal)** regulated switch mode power supply offer, thus forming a set of solutions to meet the needs for continuity of service in demanding applications.

These modules, connected to the electronic switch mode power supply outputs, offer solutions such as:

- Immunity to microbreaks (see page 18)
- Voltage holding in the event of power outages (see page 19)
- Voltage holding in the event of power supply equipment impairment (see page 20)
- Discrimination in the application's protection against overloads and short-circuits (see page 22)

Continuity of service: Immunity to microbreaks

ABL8RP/ABL8WP (Universal) power supplies can deliver their nominal power in the event of a microbreak of less than 20 ms. When outages exceed this value, the **ABL8BUF24400** Buffer Function module, combined with an **ABL8RP/ABL8WP (Universal)** power supply, is used. In the event of short interruptions, the Buffer module takes over and continues to provide the 24 V $\overline{\text{---}}$ voltage.

The table below indicates the maximum time for immunity to microbreaks t_1 .

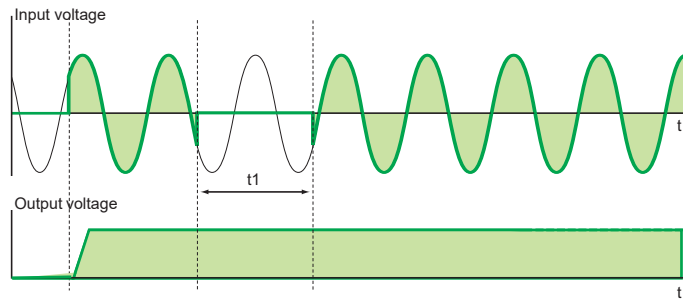

Power supply	Typical time for immunity to microbreaks with Buffer module (40 A) at U_n t_1	
	100% load at the Buffer module output	2 A at the Buffer module output
ABL8RPS24030 Single-phase or 2-phase 3 A, 72 W	0.912 s	0.984 s
ABL8RPS24050 Single-phase or 2-phase 5 A, 120 W	0.472 s	1.33 s
ABL8RPS24100 Single-phase or 2-phase 10 A, 240 W	0.220 s	1.34 s
ABL8RPM24200 Single-phase or 2-phase 20 A, 480 W	0.206 s	1.82 s
ABL8WPS24200 3-phase 20 A, 480 W	0.056 s (1)	1.18 s
ABL8WPS24400 3-phase 40 A, 960 W	0.092 s (1)	1.29 s

Note: In order to maximize the immunity time, it is advisable to connect only those circuits requiring protection against microbreaks (controller or PLC power supply) at the Buffer module output.

(1) Values liable to increase significantly. Please consult our website www.schneider-electric.com

Power supplies

Phaseo ABL7, ABL8

ABL8B Function modules: Solutions to microbreaks and power outages

Continuity of service: Voltage holding in the event of a power outage (continued)

For applications that are sensitive to unintended stopping, the **ABL8B** range of Function modules offers a solution comprising:

- Electronic switch mode power supply and Buffer module for holding times t_2 up to two seconds
- Electronic switch mode power supply, Battery control module and Battery module for holding times t_2 of between two seconds and a few hours

These solutions are used to supply voltage after loss of the line supply, thus enabling saving of current values or fallback of some actuators supplied with 24 V $\overline{\text{---}}$.

The table below indicates the possible holding times according to the equipment combinations and the current required.

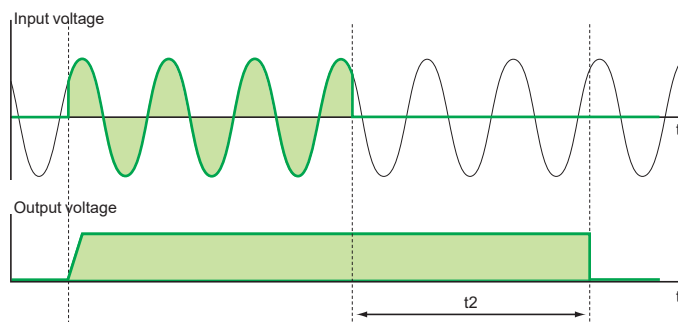

Holding current	Holding time t_2																										
	Seconds									Minutes								Hours									
	0.1	0.2	0.5	1	2	5	10	30	1	2	3	4	5	6	7	8	9	10	15	20	30	40	50	1	2	3	5
1 A	1	1	1	1	1	2+4	2+4	2+4	2+4	2+4	2+4	2+4	2+4	2+4	2+4	2+4	2+4	2+4	2+4	2+4	2+4	2+4	2+4	2+4	2+4	2+5	2+5
2 A	1	1	1	1	1	2+4	2+4	2+4	2+4	2+4	2+4	2+4	2+4	2+4	2+4	2+4	2+4	2+4	2+4	2+4	2+4	2+4	2+4	2+4	2+5	2+6	2+6
3 A	1	1	1	1	2+4	2+4	2+4	2+4	2+4	2+4	2+4	2+4	2+4	2+4	2+4	2+4	2+4	2+4	2+4	2+4	2+4	2+5	2+5	2+5	2+6	2+6	2+6 +6
4 A	1	1	1	1	2+4	2+4	2+4	2+4	2+4	2+4	2+4	2+4	2+4	2+4	2+4	2+4	2+4	2+4	2+4	2+4	2+5	2+5	2+5	2+5	2+6	2+6 +6	2+6 +6
5 A	1	1	1	2+4	2+4	2+4	2+4	2+4	2+4	2+4	2+4	2+4	2+4	2+4	2+4	2+4	2+4	2+4	2+4	2+5	2+5	2+5	2+6	2+6	2+6 +6	2+6 +6	
6 A	1	1	1	2+4	2+4	2+4	2+4	2+4	2+4	2+4	2+4	2+4	2+4	2+4	2+4	2+4	2+4	2+4	2+5	2+5	2+5	2+6	2+6	2+6	2+6 +6	2+6 +6	
7 A	1	1	1	2+4	2+4	2+4	2+4	2+4	2+4	2+4	2+4	2+4	2+4	2+4	2+5	2+5	2+5	2+5	2+5	2+5	2+6	2+6	2+6	2+6	2+6 +6	2+6 +6	
8 A	1	1	1	2+4	2+4	2+4	2+4	2+4	2+4	2+4	2+4	2+4	2+4	2+5	2+5	2+5	2+5	2+5	2+5	2+5	2+6	2+6	2+6	2+6	2+6 +6	2+6 +6	
10 A	1	1	2+4	2+4	2+4	2+4	2+4	2+4	2+4	2+4	2+4	2+4	2+5	2+5	2+5	2+5	2+5	2+5	2+5	2+6	2+6	2+6	2+6	2+6 +6	2+6 +6	2+6 +6	
15 A	1	1	2+4	2+4	2+4	2+4	2+4	2+4	2+4	2+4	2+4	2+5	2+5	2+5	2+5	2+5	2+6	2+6	2+6	2+6	2+6	2+6	2+6 +6	2+6 +6	2+6 +6		
20 A	1	1	2+5	2+5	2+5	2+5	2+5	2+5	2+5	2+5	2+5	2+5	2+6	2+6	2+6	2+6	2+6	2+6	2+6	2+6	2+6	2+6	2+6 +6	2+6 +6			
25 A	1	3+5	3+5	3+5	3+5	3+5	3+5	3+5	3+5	3+5	3+5	3+6	3+6	3+6	3+6	3+6	3+6	3+6	3+6	3+6	3+6	3+6	3+6 +6	3+6 +6	3+6 +6		
30 A	1	3+5	3+5	3+5	3+5	3+5	3+5	3+5	3+5	3+5	3+6	3+6	3+6	3+6	3+6	3+6	3+6	3+6	3+6	3+6	3+6	3+6	3+6 +6	3+6 +6	3+6 +6		
35 A	1	3+5	3+5	3+5	3+5	3+5	3+5	3+5	3+6	3+6	3+6	3+6	3+6	3+6	3+6	3+6	3+6	3+6	3+6	3+6	3+6	3+6	3+6 +6	3+6 +6	3+6 +6		
40 A	1	3+6	3+6	3+6	3+6	3+6	3+6	3+6	3+6	3+6	3+6	3+6	3+6	3+6	3+6	3+6	3+6	3+6	3+6	3+6	3+6	3+6	3+6 +6	3+6 +6	3+6 +6		

Function modules	Reference	Code
40 A Buffer module	ABL8BUF24400	1
20 A Battery control module	ABL8BBU24200	2
40 A Battery control module	ABL8BBU24400	3
3.2 Ah Battery module	ABL8BPK24A03	4
7 Ah Battery module	ABL8BPK24A07	5
12 Ah Battery module	ABL8BPK24A12	6

Note: Several Buffer modules (up to a maximum of three) can be connected in parallel to increase the immunity time. The times given in the table above (boxes marked 1) should be multiplied by the number of modules used (2 or 3).

Power supplies

Phaseo ABL7, ABL8

ABL8B Function modules: Solutions to microbreaks and power outages

Description

40 A Buffer module

The **ABL8BUF24400** Buffer Function module comprises:

- 1 Spring clip for 35 mm U rail
- 2 Clip-on marker label
- 3 LED indicator (green): module ready (maximum load)
- 4 10 mm² enclosed screw terminals for connection of the 24 V DC input voltage
- 5 10 mm² enclosed screw terminals for connection of the 24 V DC output voltage
- 6 Removable screw terminal block for connection of the diagnostic contact: module ready (maximum load)

20 A and 40 A Battery control modules

The **ABL8BBU24000** Battery control Function modules comprises:

- 1 Spring clip for 35 mm U rail
- 2 Clip-on marker label
- 3 Memory card slot for backup and duplication of the configuration parameters
- 4 Display and configuration parameter browse/selection button
- 5 Removable screw connector for connection of the battery voltage inhibit input (terminal block supplied)
 - ⚠ This contact must always be volt-free.
- 6 Removable screw connector for connection of the diagnostic contacts: power supply presence, battery presence (terminal block supplied)
- 7 10 mm² enclosed screw terminals for connection of the 24 V DC output voltage
- 8 10 mm² enclosed screw terminals for connection of the power supply 24 V DC input voltage
- 9 10 mm² enclosed screw terminals for connection of the battery voltage 24 V DC input voltage

3.2 Ah, 7 Ah, and 12 Ah Battery modules

The front panel of the **ABL8BPK24A00** Battery Function modules comprises:

- 1 A metal box that can be fixed on a vertical or horizontal panel
- 2 Fuse carrier (one or two depending on the model), which, in addition to protect the output, can be used to disable the battery module (fuse supplied but not fitted)
- 3 10 mm² enclosed screw terminals for connection of the Battery module 24 V DC output voltage (depending on the model, allows two Battery modules to be connected in parallel)
- 4 Fuse storage attachment

Functions

ABL8BBU24000 Battery control modules

The main module functions are:

- Charging and checking the associated battery
- Automatic switching between the power supply and the battery in the event of a power outage
- Diagnostics

The Battery control modules offer a three-color LCD screen and a navigation button that can be used to:

- Display the status and diagnostic data
- Access the service and maintenance functions
- Set the module parameters

These modules also have a diagnostic relay (C/O contacts) relating to:

- The power supply status
- The Battery module status
- The alarm

The following functions are available:

- Inhibition or activation (local or remote) of the battery in order to do maintenance operations on the application
- Battery test
- Backup and download of a configuration via a memory card enabling storage and duplication of the configuration parameters

The module parameters can be set in order to define:

- The user language
- The rating of the battery connected to the Battery control module
- The operating temperature for the battery in order to optimize its life
- The length and cross-section of the connection to compensate for voltage losses due to the length of the line
- The duration of the battery-powered supply
- The threshold voltage provided by the power supply below which the battery takes over

Whichever solution is used, the output terminals for the power supplies, Buffer modules and Battery control modules have been designed to make it easier to isolate a backed-up circuit and a non-backed-up circuit to maintain continuity of service after a power outage.

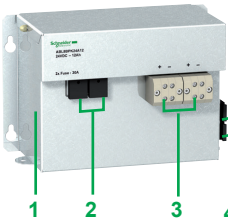
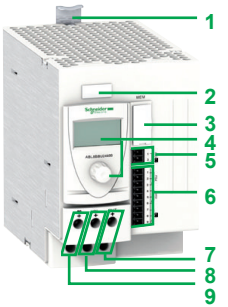

Green: Nominal status/information



Orange: Warning



Red: Fault

Examples of Battery control module diagnostic screens

Power supplies

Phaseo ABL7, ABL8

ABL8B Function modules: Solutions to microbreaks and power outages

Functions

ABL8BPK24A●● Battery modules

Each Battery module consists of:

- Lead-sealed batteries (two in series)
- Its automotive type fuse protection

Only these modules are compatible with the **ABL8BBU** Battery control modules.

⚠ In the event of the Battery control module-Battery module combination not being used for long periods (approximately 1 week minimum) the following is recommended:

- Fully charge the Battery module beyond 72 hours,
- Remove the fuse(s) from the Battery module(s) and store them in the allocated slots **2**

References

Function modules (compatible only with ABL8RP/ABL8WP (Universal) Phaseo power supplies)

Function	Use	Designation	Reference	Weight kg/lb
Continuity after a power outage	Holding time 100 ms at 40 A and 2 s at 1 A	Buffer module	ABL8BUF24400	1.200/ 2.646
	Holding time 9 min at 40 A...2 hrs at 1 A (depending on use with a battery control module-battery unit and load) (1)	Battery control module 20 A output current	ABL8BBU24200	0.500/ 1.102
Battery control module, 40 A output current		ABL8BBU24400	0.700/ 1.543	
3.2 Ah battery module (2)		ABL8BPK24A03	3.500/ 7.716	
7 Ah battery module (2)		ABL8BPK24A07	6.500/ 14.330	
	12 Ah battery module (2)	ABL8BPK24A12	12.000/ 26.455	

Separate and replacement parts

Designation	Description	Composition	Unit reference	Weight kg/lb
Fuse assemblies	For ABL8BPK24A●● battery	4 x 20 A and 6 x 30 A	ABL8FUS02	–
Clip-on marker labels	All products except ABL8PRP24100	Order in multiples of 100	LAD90	0.030/ 0.066
Kit for mounting on rail	For ABL8BPK2403 Battery module	Order in multiples of 5	ABL1A02	–
EEPROM memory	Backup and duplication of ABL8 BBU parameters	–	SR2MEM02	0.010/ 0.022

(1) For table of compatibility of battery control module-battery unit with holding time depending on the load, see page 17.

(2) Supplied with 20 or 30 A fuse depending on the model.



ABL8BUF24400



ABL8BBU24200



ABL8BBU24200

Power supplies

Phaseo ABL7, ABL8

ABL8RED24400 Function module: Redundancy solution

Continuity of service: Failure of power supply equipment

Where continuous operation of the application is the prime concern, it is necessary to know that when one power supply malfunctions, a second power supply takes over. The **ABL8RED24400** Redundancy module can perform this function, allowing that the failure of one power supply does not disturb the second (for example, in the event of a short-circuit of one of the power supply outputs).

The **ABL8RED24400** Redundancy module, used with two electronic switch mode power supplies of the same type, can be used to supply the nominal power to the application even if one of the power supplies fails.

The various diagnostics - on the front panel (LED) and remote (relay) - inform the maintenance team as soon as the first fault occurs on one of the power supplies.

When continuity of service is critical for the application, it may be necessary to provide redundancy for the Redundancy module.

Note: The Redundancy module can be used to connect two power supplies with a maximum rating of 20 A in parallel. To connect two 40 A **ABL8WPS24400** power supplies, two **ABL8RED24400** Redundancy modules must be used.

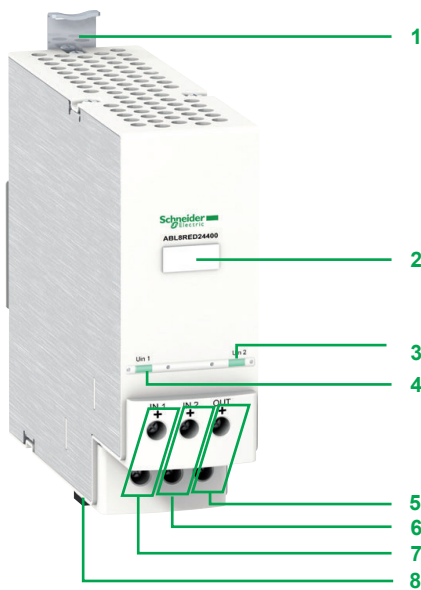

Description

2 x 20 A Redundancy module

The **ABL8RED24400** Redundancy Function module comprises:

- 1 Spring clip for 35 mm rail
- 2 Clip-on marker label
- 3 Input voltage status LED (green) for the first 24 V --- power supply
- 4 Input voltage status LED (green) for the second 24 V --- power supply
- 5 10 mm² enclosed screw terminals for connection of the 24 V --- output voltage
- 6 10 mm² enclosed screw terminals for connection of the input voltage for the second 24 V --- power supply ($I \leq 20$ A)
- 7 10 mm² enclosed screw terminals for connection of the input voltage for the first 24 V --- power supply ($I \leq 20$ A)
- 8 Removable screw terminal block for connection of the diagnostic contact

Power supplies

Phaseo ABL7, ABL8

ABL8RED24400 Function module: Redundancy solution



ABL8RED24400

Function module (compatible only with ABL8RP/ABL8WP (Universal) Phaseo power supplies)

Function	Use	Designation	Reference	Weight kg/lb
Continuity after a failure	Paralleling and redundancy of the power supply to ensure uninterrupted operation of the application excluding AC line failures and application overloads	Redundancy module	ABL8RED24400	0.700/ 1.543

Replacement part

Designation	Composition	Unit reference	Weight kg/lb
Clip-on marker labels	Order in multiples of 100	LAD90	0.030/ 0.066

Power supplies

Phaseo ABL7, ABL8

Function modules ABL8PRP24100: Solution for discriminating protection of the application

Continuity of service: Discrimination of protection against overloads and short-circuits

There is no point in using thermal-magnetic circuit-breakers or fuses downstream of an electronic switch mode power supply in the majority of cases. When a short-circuit or very quick overload occurs in the application, the electronic protection is faster than the thermal-magnetic circuit-breaker or fuse. In this case, none of the circuits are powered.

To provide discriminating protection in the event of an overload or short-circuit, the **ABL8RP/ABL8WP (Universal)** Phaseo power supply electronic protection function has been integrated in four-channel modules. These discriminating downstream Protection modules can be daisy-chained to provide protection discrimination on as many application segments as necessary.

The **ABL8PRP24100** discriminating downstream Protection module have:

- Overload and short-circuit protection on each of their four channels:
- Each channel can be calibrated by the user from 1 to 10 A, according to the needs of the application.
- One fuse per channel (15 A supplied by default) gives ultimate protection in the event of a module fault. This fuse can be replaced by a fuse with a lower rating that is appropriate for the conductor c.s.a. used for cabling.
- A 2-pole isolator on each of its channels
- An automatic or manual reset mode for the protection
- Memorization of the fault even in the event of failure of the 24 V $\bar{\bar{c}}$ voltage
- A diagnostic relay indicating that each channel is operational
- One diagnostic LED per channel
- Manual reset on the front panel
- One switch per channel that can be used, like thermal-magnetic circuit-breakers, to open or close the circuits during test, maintenance or installation periods

Description

Single-pole and 2-pole downstream electronic Protection module

The **ABL8PRP24100** 4-channel downstream electronic Protection module comprises:

- 1 10 mm² enclosed screw terminals for connection of the 24 V $\bar{\bar{c}}$ voltage
- 2 Enclosed screw terminals for connection of the diagnostic relay contact
- 3 Line protection fuses (one 15 A fuse per channel by default)
- 4 Automatic or manual reset mode selector
- 5 Reset pushbutton
- 6 Diagnostic LEDs (green and red) and clip-on marker tag holder (1 per channel)
- 7 1...10 A output nominal current selector (1 per channel)
- 8 Channel isolator switch (1 per channel)
- 9 Locking catch for the glass flap (sealable).
- 10 4 mm² enclosed screw terminals for connection of the four channels (2-pole)
- 11 Protective glass flap
- 12 Retractable fixing lugs for panel mounting (DIN rail mounting also possible)

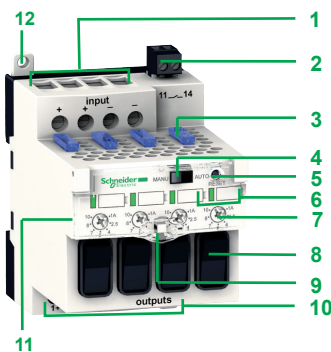

Power supplies

Phaseo ABL7, ABL8

Function modules ABL8PRP24100: Solution for discriminating protection of the application

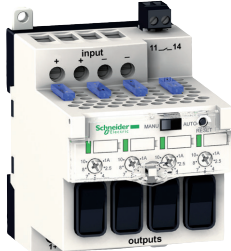

ABL8PRP24100

References

Function modules (compatible only with ABL8RP/ABL8WP (Universal) Phaseo power supplies)

Function	Use	Designation	Reference	Weight kg/lb
Discriminating downstream protection	Electronic protection (1...10 A overload or short-circuit) of 4 output terminals from a Phaseo ABL8RP/ABL8WP (Universal) range power supply	Universal Protection module with 2-pole breaking (1)	ABL8PRP24100	0.470/ 1.036

Separate part

Designation	Use	Composition	Unit reference	Weight kg/lb
Fuse set	For ABL8PRP24100 module	4 x 5 A, 4 x 7.5 A and 4 x 10 A	ABL8FUS01	0.018/ 0.040

Replacement part

Designation	Use	Composition	Unit reference	Weight kg/lb
Clip-on marker labels	For ABL8PRP24100 module	Order in multiples of 22	ASI20MACC5	0.015/ 0.033

(1) Local reset via pushbutton or automatic reset.

A	
ABL1A02	13 19
ABL7RM24025	7
ABL7RP1205	9
ABL7RP4803	9
ABL8BBU24200	13 19
ABL8BBU24400	13 19
ABL8BPK24A03	13 19
ABL8BPK24A07	13 19
ABL8BPK24A12	13 19
ABL8BUF24400	13 19
ABL8DCC05060	13 15
ABL8DCC12020	13 15
ABL8FUS01	13 23
ABL8FUS02	13 19
ABL8MEM05040	7
ABL8MEM12020	7
ABL8MEM24003	7
ABL8MEM24006	7
ABL8MEM24012	7
ABL8PRP24100	13 23
ABL8RED24400	13 21
ABL8REM24030	9
ABL8REM24050	9
ABL8RPM24200	13
ABL8RPS24030	13
ABL8RPS24050	13
ABL8RPS24100	13
ABL8WPS24200	13
ABL8WPS24400	13
ASI20MACC5	13 23
L	
LAD90	7 13 15 19 21
S	
SR2MEM02	13 19



www.schneider-electric.com/msx

Schneider Electric Industries SAS

Head Office
35, rue Joseph Monier
F-92500 Rueil-Malmaison
France

The information provided in this documentation contains general descriptions and/or technical characteristics of the performance of the products contained herein. This documentation is not intended as a substitute for and is not to be used for determining suitability or reliability of these products for specific user applications. It is the duty of any such user or integrator to perform the appropriate and complete risk analysis, evaluation and testing of the products with respect to the relevant specific application or use thereof. Neither Schneider Electric nor any of its affiliates or subsidiaries shall be responsible or liable for misuse of the information contained herein.

Design: Schneider Electric
Photos: Schneider Electric